

Accessori

**tierre 600TH**

*Accessories*



## ACCESSORI TIERRE 600TH "VARI"

sigla	profilo	descrizione
Ra 1033		CAPPETTA DI DRENAGGIO
Ra 1404		REGOLATORE A MURO
Ra 1420		CAVALLOTTO PER TR2810
Ra 1421		CAVALLOTTO PER TR2811
Ra 1422		ANGOLI PER FERMAVETRI ARROTONDATI
Ra 2601		BOCCOLA SCARICO ACQUA
Ra 1737		CLIP PER FERMAVETRI
Ra 2342		RUOTA PER INSERIMENTO GUARNIZIONE Rg 364





## ACCESSORI TIERRE 600TH "SQUADRETTE"

sigla	profilo	descrizione
Ra 1048		SQUADRETTA A TIRAGGIO MECCANICO PER IMBOTTI CAPANNONI
Ra 1410		SQUADRETTA DI ALLINEAMENTO PER TR2829, TR2830, TR2835 TR2839 E TR2839
Ra 1411		SQUADRETTA DI ALLINEAMENTO PER IMBOTTI CAPANNONI
Ra 1704		SQUADRETTA DI ALLINEAMENTO PER ANTE V.I.
Ra 3804		SQUADRETTA DI ALLINEAMENTO A TIRAGGIO PER TR2820, TR2821, TR2832, TR2833
Ra 1711		SQUADRETTA A CIANFRINARE CASSA INTERNA





## ACCESSORI TIERRE 600TH "SQUADRETTE"

sigla	profilo	descrizione
Ra 3813		SQUADRETTA A TIRAGGIO MECCANICO CASSA INTERNA CON BOTTONE DA 8 mm
Ra 3817		SQUADRETTA A TIRAGGIO MECCANICO CASSA INTERNA PER MAGGIORATI CON BOTTONE DA 8 mm
Ra 1423		SPINA DA 8 mm
Ra 1705		SQUADRETTA A SPINARE CASSA INTERNA
Ra 1707		SQUADRETTA A SPINARE CASSA INTERNA PER MAGGIORATI
Ra 1714		SQUADRETTA A SPINARE CASSA INTERNA PER TR2831 E TR2841
Ra 1738		SQUADRETTA DI ALLINEAMENTO A TIRAGGIO
Ra 3806		SQUADRETTA A CIANFRINARE
Ra 3807		SQUADRETTA A CIANFRINARE CASSA ESTERNA PER ANTE
Ra 3808		SQUADRETTA A CIANFRINARE CASSA ESTERNA PER ANTA TR2806 E TR2832
Ra 3809		SQUADRETTA A CIANFRINARE CASSA ESTERNA PER ANTA TR 2831 E TR2841
Ra 2006		SQUADRETTA A CIANFRINARE CASSA ESTERNA TELAI E ANTE MAGGIORATE
Ra 1709		SQUADRETTA A CIANFRINARE CASSA ESTERNA TELAI E ANTE

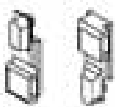

## ACCESSORI TIERRE 600TH "CERNIERE"

sigla	profilo	descrizione
Ra 1427		CERNIERA FLASH BASE
Ra 1428		CERNIERA FLASH BASE PER SOLUZIONE COMPLANARE O 3ª ANTA
Ra 1430		CERNIERA PER PORTE FLASH XL
Ra 1431		CERNIERE PER PORTE FLASH XL SOL. COMPLANARE O 3ª ANTA
Ra 1440		CERNIERA PER VASISTAS









## ACCESSORI TIERRE 600TH "CREMONESI"

sigla	profilo	descrizione
Ra 1031		CREMONESE UNICA SENZA ARTICOLI CORRELATI
Ra 1056		CREMONESE PRIMA
Ra 1057		CREMONESE PRIMA 900 PER ANTA RIBALTA
Ra 1447		BLOCCHETTI DI COLLEGAMENTO
Ra 1454		CURSORI E VITI IN ABBINAMENTO A Ra 1031 PER APERTURA INTERNA
Ra 1429		CRICCHETTO CICO















## ACCESSORI TIERRE 600TH "TAPPI"

sigla	profilo	descrizione
Ra 3802		TAPPO RISCONTRO CENTRALE GIUNTO APERTO
Ra 3803		TAPPO RISCONTRO CENTRALE DOPPIA BATTUTA
Ra 3818		TAPPO RISCONTRO CENTRALE PER SISTEMA CON FERRAMENTA A NASTRO











## ACCESSORI TIERRE 600TH "ACCESSORI DI CHIUSURA"

sigla	profilo	descrizione
Ra 1002		TERMINALE PER ASTE
Ra 1035		CATENACCIO GIAP
Ra 2905		INCONTRO ASTE E TERZA CHIUSURA
Ra 2906		INCONTRO SINGOLO O DOPPIO
Ra 2907		INCONTRO PER art. Ra 2918
Ra 2908		INCONTRO DOPPIO
Ra 2909		ROSTRO DI CHIUSURA REGISTRABILE
Ra 2910		BRACCIO LIMITATORE DI APERTURA FRIZ
Ra 2911		BRACCIO LUNGO RALLENTY mm 250

## ACCESSORI TIERRE 600TH "ACCESSORI DI CHIUSURA"

sigla	profilo	descrizione
Ra 2912		BRACCIO CORTO RALLENTY mm 150
Ra 2913		CATENACCIO REGISTRABILE
Ra 2914		TAPPO SOSTENIMENTO ANTE
Ra 2915		MARTELLINA MASTERMAR
Ra 2918		NOTTOLINO DI CHIUSURA
Ra 1433		MOVIMENTAZIONE INTERNA BIDIREZIONALE
Ra 1436		INCONTRO PER DOPPIA E TERZA CHIUSURA
Ra 1437		INCONTRO SINGOLO
Ra 1441		TERMINALE REGISTRABILE
Ra 1442		CATENACCIO TOTEM
Ra 1444		COMANDO BIDIREZIONALE A LEVA
Ra 1445		FERMA ANTA
Ra 1452		ASTINA DI COLLEGAMENTO 15/20
Ra 1457		SERRATURA DI BLOCCAGGIO

## ACCESSORI TIERRE 600TH "ANTA RIBALTA BASE"

sigla	profilo	descrizione
Ra 1458		MECC. BASE AR FUTURA
Ra 1459		BRACCIO TIPO 1 ANTA RIBALTA FUTURA
Ra 1460		BRACCIO TIPO 2 ANTA RIBALTA FUTURA
Ra 1461		CHIUSURA SUPPLEMENTARE FUTURA
Ra 2921		CATENACCIO REGISTRABILE ANTA ABBINATA
Ra 2922		CATENACCIO GIAP ANTA ABBINATA
Ra 2923		BRACCIO SUPPLEMENTARE PER ANTA RIBALTA
Ra 1456		CATENACCIO ANTA ABBINATA
Ra 1443		COMANDO BIDIREZIONALE A LEVA NELLA SOLUZIONE ANTA RIBALTA
Ra 1435		MOVIMENTAZIONE INTERNA MONODIREZIONALE
Ra 1462		CERNIERA ANTA ABBINATA

## ACCESSORI TIERRE 600TH "ANTA RIBALTA COMPLANARE"

sigla	profilo	descrizione
Ra 1455		MECCANISMO ANTA RIBALTA PER SOLUZIONE COMPLANARE

## ACCESSORI TIERRE 600TH "ANTA RIBALTA COMPLANARE"

sigla	profilo	descrizione
Ra 1025		CATENACCI ANTA ABBINATA A Ra 1455
Ra 1044		BRACCIO TIPO 1 ANTA RIBALTA APPLICABILE A Ra 1455
Ra 1045		BRACCIO TIPO 2 ANTA RIBALTA APPLICABILE A Ra 1455
Ra 2919		CHIUSURE SUPPL. VERTICALI APPLICABILI A Ra 1455
Ra 2920		CHIUSURE SUPPL. ORIZZONTALI APPLICABILI A Ra 1455

## ACCESSORI TIERRE 600TH "BILICO"

sigla	profilo	descrizione
Ra 1438		SNODO A FRIZIONE PER BILICO
Ra 1439		MANIGLIA A TAVELLINO "BRAVO 1" PER SOLUZIONI COMPLANARI
Ra 2916		MARTELLINA LINEA PRIMA PER BILICO
Ra 1453		RINVIO D'ANGOLO PER CHIUSURA PERIMETRALE E APERTURA ESTERNA
Ra 1446		PERNO DI COLLEGAMENTO PER BILICO
Ra 1434		MOVIMENTAZIONE INTERNA BIDIREZIONALE PER BILICO











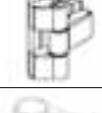

## ACCESSORI TIERRE 600TH "SPORGERE"

sigla	profilo	descrizione
Ra 1729		BRACCIO PER SPORGERE
Ra 1730		MANIGLIA A TAVELLINO "BRAVO 1" PER GRADINO 8 mm
Ra 1731		KIT PER APERTURA ESTERNA MONODIREZIONALE
Ra 1732		TRAINO PER ASTINA
Ra 1733		BRACCI LASER INOX
Ra 1734		BRACCI LASER ZINCATO

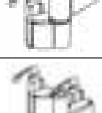
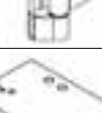
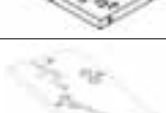
## ACCESSORI TIERRE 600TH "MONOBLOCCO"

sigla	profilo	descrizione
Ra 1036		PASSACINTINO
Ra 1058		TAPPO RACCOGLI CONDENSA
Ra 1073		TAPPI CASSONETTO MONOBLOCCO
Ra 1419		COPPIA INVITI PER GUIDA TAPPARELLA
Ra 1476		KIT MOVIMENTAZIONE MONOBLOCCO



## ACCESSORI TIERRE 600TH "SERIE PORTA"

sigla	profilo	descrizione
Ra 1426		CERNIERA DOMINA 2 ALI int. 55,5 mm
Ra 1432		CERNIERA DOMINA 2 ALI 3D int. 55,5 mm
Ra 1424		CERNIERA DOMINA 2 ALI int. 61 mm
Ra 1425		CERNIERA DOMINA 3 ALI int. 61 mm
Ra 1463		CERNIERA DOMINA HP 2 ALI int. 62,5 mm
Ra 1464		CERNIERA DOMINA HP 3 ALI int. 62,5 mm
Ra 1473		CERNIERA DOMINA 2 ALI INTERASSE 68,5 mm
Ra 1474		CERNIERA DOMINA 3 ALI INTERASSE 68,5 mm
Ra 1448		DIMA PER CERNIERA Ra1426
Ra 1451		DIMA PER CERNIERA Ra1432
Ra 1449		DIMA PER CERNIERE Ra1424 e Ra1425
Ra 1450		DIMA PER CERNIERE Ra1463 e Ra1464
Ra 1475		DIMA PER CERNIERE Ra 1473 e Ra 1474
Ra 1466		DOPPIA MANIGLIA PER MONTANTE



## ACCESSORI TIERRE 600TH "SERIE PORTA"

sigla	profilo	descrizione
Ra 1467		DOPPIA MANIGLIA PER FASCIA
Ra 2327		KIT DI TENUTA SOTTOZOCICOLO 1
Ra 2328		KIT DI TENUTA SOTTOZOCICOLO 2

## ACCESSORI TIERRE 600TH "GRUPPI FRESE E PUNZONATRICI"

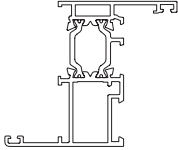
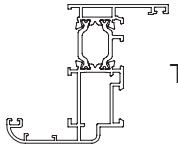
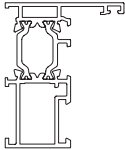
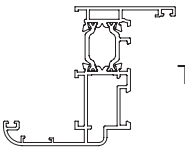
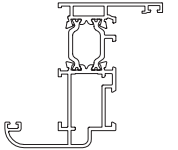
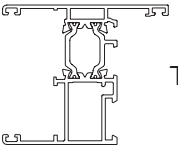
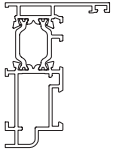
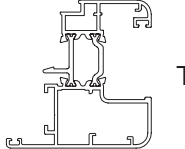
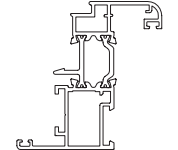
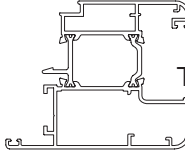
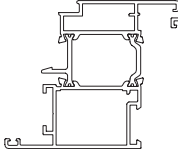
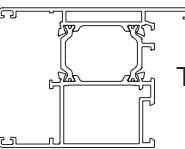
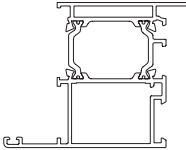
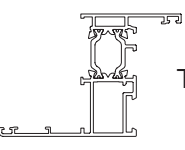
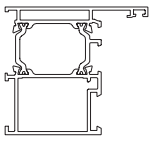
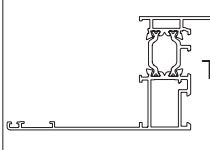
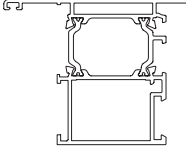
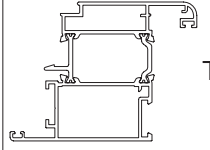
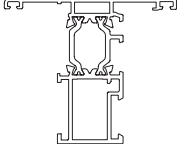
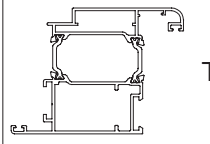
sigla	profilo	descrizione
Ra 3800		PUNZONATRICE TIERRE
Ra 3816		GRUPPO FRESE TIERRE 600TH

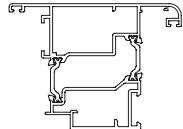
profili	sigla	squadretta a spinare bottone CASSA INTERNA	squadretta a cianfrinare e/o allineamento CASSA ESTERNA	profili	sigla	squadretta a spinare bottone CASSA INTERNA	squadretta a cianfrinare e/o allineamento CASSA ESTERNA
	TR 2801	Ra 1705 Ra 3813 Ra 1711	Ra 1709 Ra 1738		TR 2820	Ra 1705 Ra 3813 Ra 1711 Ra 3804	Ra 1709 Ra 1738
	TR 2802	Ra 1705 Ra 3813 Ra 1711	Ra 1709 Ra 1738		TR 2821	Ra 1705 Ra 3813 Ra 1711 Ra 3804	Ra 1709 Ra 1738
	TR 2803	Ra 1705 Ra 3813 Ra 1711	Ra 1709 Ra 1738		TR 2823	Ra 1705 Ra 3813 Ra 1711	Ra 1709 Ra 1738
	TR 2804	Ra 1705 Ra 3813 Ra 1711	Ra 1709 Ra 1738		TR 2824	Ra 1705 Ra 3813 Ra 1711 Ra 1704	Ra 3807 Ra 1738
	TR 2805	Ra 1705 Ra 3813 Ra 1711	Ra 3807 Ra 1738		TR 2825	Ra 1707 Ra 3817 Ra 1704	Ra 3808 Ra 1738
	TR 2806	Ra 1707 Ra 3817	Ra 3808 Ra 1738		TR 2828	Ra 1707 Ra 3817	Ra 2006 Ra 1738
	TR 2816	Ra 1707 Ra 3817	Ra 2006 Ra 1738		TR 2829	Ra 1705 Ra 3813 Ra 1711 Ra 1410	Ra 1709 Ra 1738
	TR 2817	Ra 1707 Ra 3817	Ra 2006 Ra 1738		TR 2830	Ra 1705 Ra 3813 Ra 1711 Ra 1410	Ra 1709 Ra 1738
	TR 2818	Ra 1707 Ra 3817	Ra 2006 Ra 1738		TR 2831	Ra 1714	Ra 3809 Ra 1738
	TR 2819	Ra 1705 Ra 3813 Ra 1711	Ra 1709 Ra 1738		TR 2832	Ra 1707 Ra 3817	Ra 3808 Ra 3804

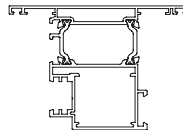
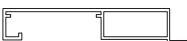
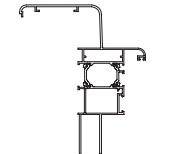
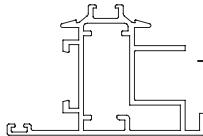
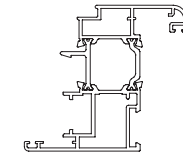
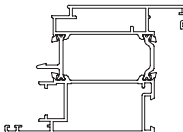
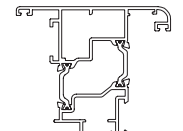
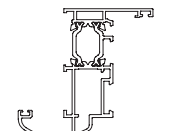
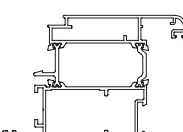
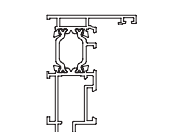
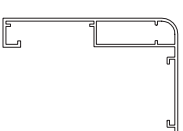
profili	sigla	squadretta a spinare bottone CASSA INTERNA	squadretta a cianfrinare e/o allineamento CASSA ESTERNA	profili	sigla	squadretta a spinare bottone CASSA INTERNA	squadretta a cianfrinare e/o allineamento CASSA ESTERNA
	TR 2833	Ra 3806	Ra 1707 Ra 3817 Ra 3804		AZ 4592	Ra 1411 Ra 1048	-
	TR 2835	Ra 1707 Ra 3817	Ra 1410		AZ 4617	Ra 1048	-
	TR 2838	Ra 1707 Ra 3817	Ra 3809 Ra 1411		TR 4738	Ra 1705 Ra 3813 Ra 1711	-
	TR 2839	Ra 1705 Ra 3813 Ra 1711 Ra 1410	Ra 3806 Ra 1738				
	TR 2841	Ra 1714 Ra 1410	Ra 3809 Ra 1738				
	TR 2843	Ra 3807	Ra 1705 Ra 3813 Ra 1711 Ra 3804				
	TR 2844	Ra 1705 Ra 3813 Ra 1711	Ra 1709 Ra 1738				
	TR 2845	Ra 1707 Ra 3817	Ra 3809 Ra 1738				
	TR 2846	Ra 1705 Ra 3813 Ra 1711	Ra 1709 Ra 1738				
	AZ 4591	Ra 1411 Ra 1048	-				

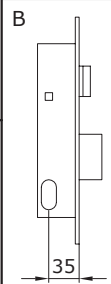
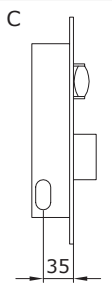
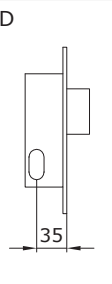
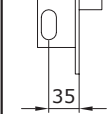
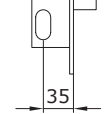
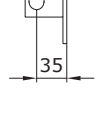

<b>Serrature a montante (cilindro ovale)</b>		<p>44221-35-0 (scrocco + 1 mandata)</p>		<p>44231-35-0 (rullo + 1 mandata)</p>		<p>44241-35-0 (1 mandata)</p>
			<p>44226-35-0 (scrocco + 2 mandate)</p>		<p>44236-35-0 (rullo + 2 mandate)</p>	

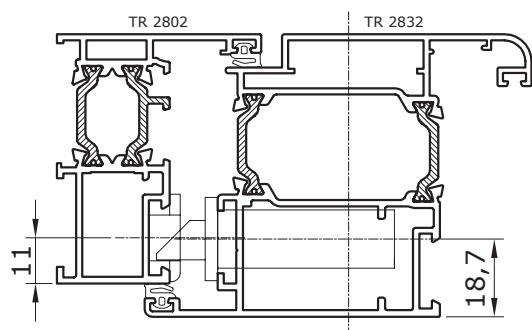
**PORTA APERTURA INTERNA 1 ANTA**

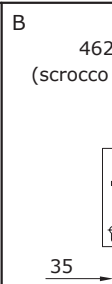

Cilindro	Contropiastra in nylon			Testata
	B	C	D	
08210-16-0 L=80.7 (27.7, 53)	06277-88	06277-90	06287-89	20

NB: Schema valido anche per porta a due ante e per soluzione apertura esterna con profilo TR 2833

<b>Serrature a montante (Catenaccio Basculante) 1 punto di chiusura</b>		<p>16215-35-0 16205-35-0 (elettrica)</p>		<p>46215-35-0 (scrocco + mandata)</p>		<p>46230-35-0 (rullo + mandata)</p>		<p>46210-35-0 (mandata)</p>

**PORTA APERTURA INTERNA 1 ANTA**

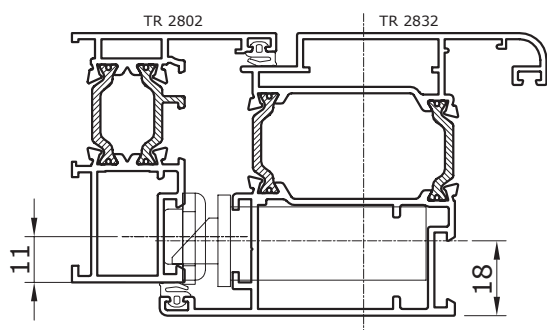

Cilindro Sagomato		Testata
Con borchie	Senza borchie	
0E300-33-0-12 L=84 (29.5-54.5)	0E300-33-0-12 L=84 (29.5-54.5)	22

Contropiastra regolabile in metallo			
A-B	C	D	
06463-22	06463-22 (*)	06465-22	
inserto per rullo 06141-71-0(*)			

NB: Schema valido anche per porta a due ante e per soluzione apertura esterna con profilo TR 2833

<p>Serrature di sicurezza montante ad ingranaggi (cilindro sagomato) 3 punti di chiusura</p>	<p><b>A</b></p> <p>18225-35-0 (elettrica)</p>	<p><b>B</b></p> <p>48225-35-0 (scrocco + mandata)</p>	<p><b>C</b></p> <p>48250-35-0 (rullo + mandata)</p>	<p><b>D</b></p> <p>48220-35-0 (mandata)</p>	<p><b>E</b></p> <p>06443-26-0 (aste esterne)</p>
--	---	---	---	---	--

PORTA APERTURA INTERNA 1 ANTA

Cilindro Sagomato		Testata
Con borchie 0E300-33-0-12 L=84 (29.5-54.5)	Senza borchie 0E300-33-0-12 L=84 (29.5-54.5)	22

Contropiastra regolabile in metallo			
A-B	C	D	E
06463-32	06463-32 (*)	06465-42	06465-42
inserto per rullo 06141-71 (*)			

NB: Schema valido anche per porta a due ante e per soluzione apertura esterna con profilo TR 2833

<p>Serrature multitop (frontale "piatto")</p>	<p><b>A</b></p> <p>48526-35-0 (scrocco + mandata)</p>	<p><b>B</b></p> <p>48551-35-0 (rullo + mandata)</p>	<p><b>C</b></p> <p>48521-35-0 (mandata)</p>
	<p>18526-35-0 (elettrica)</p>		



PORTA APERTURA INTERNA 1 ANTA

Cilindro Sagomato		Testata
Con borchie 0E300-33-0-12 L=84 (29.5-54.5)	Senza borchie 0E300-33-0-12 L=84 (29.5-54.5)	24x3

Contropiastra regolabile in metallo			
A	B	C	Deviatori
06463-32	06463-32 (*)	06465-42	06465-42 (pz. 2)
inserto per rullo 06141-71 (*)			

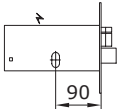
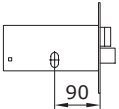
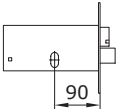
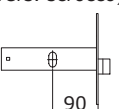
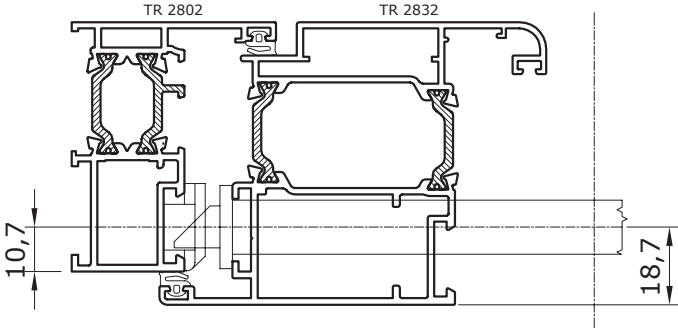
NB: Schema valido anche per porta a due ante e per soluzione apertura esterna con profilo TR 2833

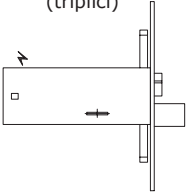
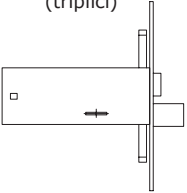
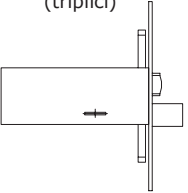
Serrature da fascia (cilindro ovale)	A 14451-90-0 14461-90-0 (elettrica)	B 44461-90-0 (scrocco + mandata)	C 44471-90-0 (rullo + mandata)	D 44161-90-0 (vers. rullo) 44151-90-0 (vers. scrocco)										
														
PORTA APERTURA INTERNA 1 ANTA														
		<table border="1"> <thead> <tr> <th>Cilindro</th> <th colspan="3">Contropiastra in nylon</th> <th>Testata</th> </tr> </thead> <tbody> <tr> <td>08210-16-0 L=80.7 (27.7, 53)</td> <td>A-B 06277-89</td> <td>C 06277-90</td> <td>D 06287-89</td> <td rowspan="2">20</td> </tr> </tbody> </table>			Cilindro	Contropiastra in nylon			Testata	08210-16-0 L=80.7 (27.7, 53)	A-B 06277-89	C 06277-90	D 06287-89	20
Cilindro	Contropiastra in nylon			Testata										
08210-16-0 L=80.7 (27.7, 53)	A-B 06277-89	C 06277-90	D 06287-89	20										
NB: Schema valido anche per porta a due ante e per soluzione apertura esterna con profilo TR 2833														

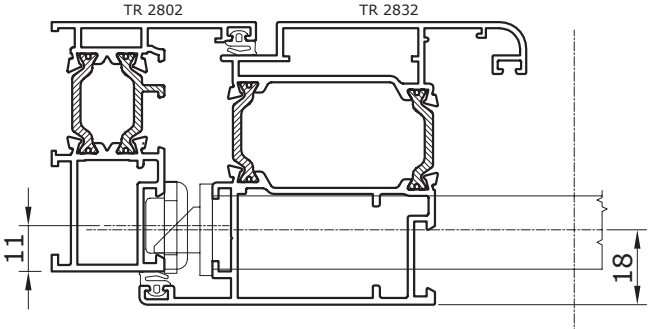
Serrature da fascia a doppia mappa	A 17357-10-0 (elettrica) (triplici)	B 57357-10-0 (scrocco + mandata) (triplici)	C 57365-10-0 (rullo + mandata) (triplici)	D 06443-05-0 (aste esterne)											
															
PORTA APERTURA INTERNA 1 ANTA															
		<table border="1"> <thead> <tr> <th colspan="3">Contropiastra regolabile in metallo</th> <th>Testata</th> </tr> </thead> <tbody> <tr> <td>A-B 06465-22</td> <td>C 06465-22 (*)</td> <td>D 06465-22</td> <td rowspan="2">22</td> </tr> <tr> <td colspan="3">inserto per rullo 06141-71 (*)</td> </tr> </tbody> </table>			Contropiastra regolabile in metallo			Testata	A-B 06465-22	C 06465-22 (*)	D 06465-22	22	inserto per rullo 06141-71 (*)		
Contropiastra regolabile in metallo			Testata												
A-B 06465-22	C 06465-22 (*)	D 06465-22	22												
inserto per rullo 06141-71 (*)															
NB: Schema valido anche per porta a due ante e per soluzione apertura esterna con profilo TR 2833															









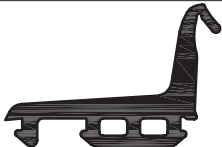
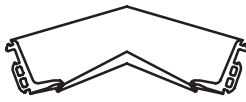

Guarnizioni

**tierre 600TH**

*Weatherstrips*



Scala 1:1

Rg 402		Guarnizione di battuta interna Materiale EPDM	3 Rotoli da 300 m
Rg 364		Guarnizione centrale di tenuta Materiale EPDM	4 Rotoli da 50 m
Rg 365		Angolo Vulcanizzato per Rg 364 Materiale EPDM	50 pezzi
Rg 331		Guarnizione per riscontro centrale Materiale EPDM	3 Rotoli da 300 m
Rg 361		Guarnizione di battuta - soluzione a doppia battuta - Materiale EPDM	2 Rotoli da 300 m
Rg 303		Guarnizione per riscontro centrale - soluzione doppia battuta - Materiale EPDM	2 Rotoli da 300 m
Rg 354		Guarnizione di isolamento soglia Materiale EPDM	2 Rotoli da 50 m
Rg 329		Guarnizione copricava Materiale EPDM	2 Rotoli da 150 m
Rg 356		Guarnizione per bilico Materiale EPDM	2 Rotoli da 300 m
Rg 358		Spugna per Monoblocco	
Rg 350		Guarnizione esterna vetro per vano da 2,5 mm Materiale EPDM	Rotolo da 200 m

Scala 1:1

Rg 351		Guarnizione esterna vetro per vano da 3,5 mm Materiale EPDM	Rotolo da 150 m
Rg 360		Guarnizione esterna vetro per vano da 5 mm Materiale EPDM	Rotolo da 150 m
Rg 307		Guarnizione interna vetro per vano da 2 mm Materiale EPDM	2 Rotoli da 300 m
Rg 320		Guarnizione interna vetro per vano da 3 mm Materiale EPDM	2 Rotoli da 200 m
Rg 308		Guarnizione interna vetro per vano da 4 mm Materiale EPDM	2 Rotoli da 150 m
Rg 321		Guarnizione interna vetro per vano da 5 mm Materiale EPDM	2 Rotoli da 150 m
Rg 309		Guarnizione interna vetro per vano da 6 mm Materiale EPDM	2 Rotoli da 100 m



## PROFILO IN PVC

Rg 333		Profilo Canalina per sistema con ferramenta a nastro Materiale PVC	confezioni in barre
--------	---	--	------------------------

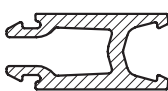
## PROFILO IN POLIAMMIDE

Rg 306		Profilo per bilico Materiale POLIAMMIDE	confezioni in barre
--------	---	--	------------------------

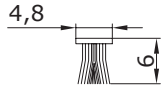
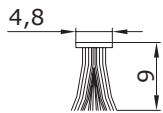
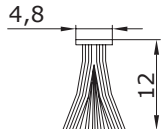
Scala 1:1

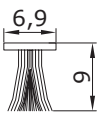
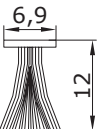
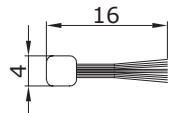
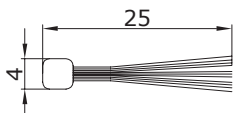
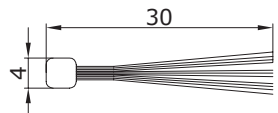
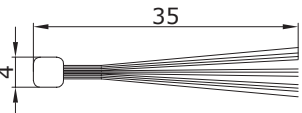
48 x 600		Guarnizione a spazzola 4,8 x 6 mm Materiale polipropilene	4 Rotoli da 400 m
48 x 900		Guarnizione a spazzola 4,8 x 9 mm Materiale polipropilene	4 Rotoli da 200 m
48 x 1200		Guarnizione a spazzola 4,8 x 12 mm Materiale polipropilene	2 Rotoli da 200 m
69 x 600		Guarnizione a spazzola 6,9 x 6 mm Materiale polipropilene	5 Rotoli da 100 m
69 x 900		Guarnizione a spazzola 6,9 x 9 mm Materiale polipropilene	4 Rotoli da 200 m
69 x 1200		Guarnizione a spazzola 6,9 x 12 mm Materiale polipropilene	2 Rotoli da 200 m
40 x 1600		Guarnizione sottozoccolo a spazzola 16 mm Materiale polipropilene	barre da 2 m
40 x 2500		Guarnizione sottozoccolo a spazzola 25 mm Materiale polipropilene	barre da 2 m
40 x 3000		Guarnizione sottozoccolo a spazzola 30 mm Materiale polipropilene	barre da 2 m
40 x 3500		Guarnizione sottozoccolo a spazzola 35 mm Materiale polipropilene	barre da 2 m